

圆柱滚子轴承

d 60-65mm-NJ2212-E-TVP2

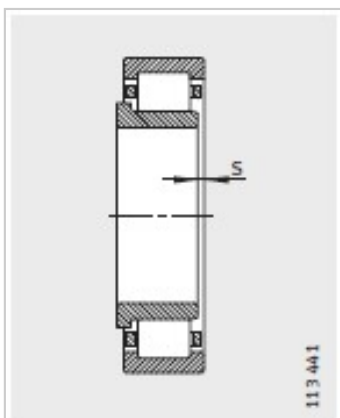
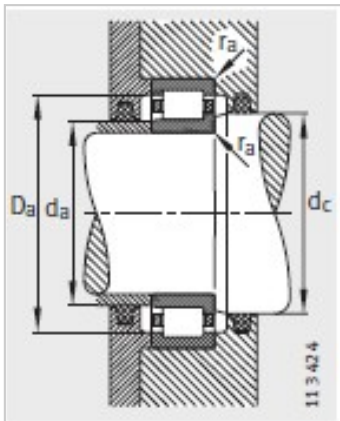
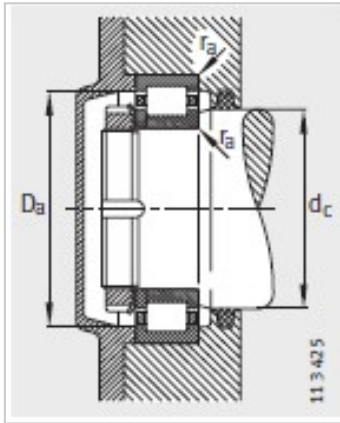

型号 :

轴承 : NJ2212-E-TVP2

X-life : XL

L形斜挡圈 : HJ212-E

质量 m :

轴承 kg : 1.1

L形斜挡圈 kg : 0.106

尺寸mm :

d : 60

D : 110

B : 28

r min : 1.5

rmin : 1.5

s : -

E : 100

F : 72

D : 96.1

d : 77.6

B : 6

B : 10

B3 : -

安装尺寸mm :

d : 69

dmax : -

d min : 80

D : 101

rmax : 1.5

基本额定载荷N :

动载荷 : 151000

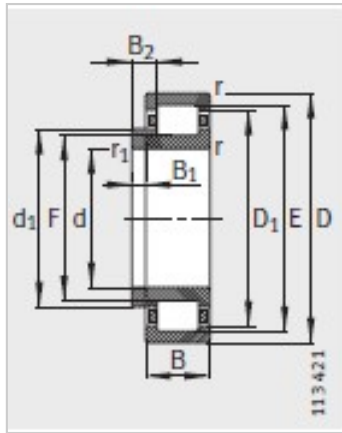

静载荷 :	152000
疲劳极限载荷Cur/N :	26500
极限转速nG/min - 1 :	6300
参考转速nB/min - 1 :	4400

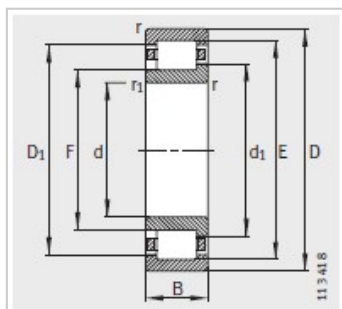
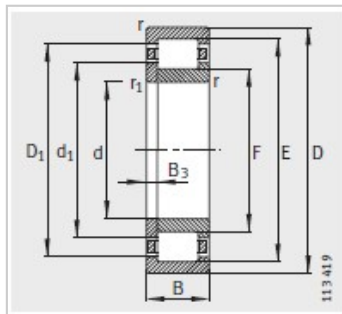

: